



NTSC U/C

PlayStation™

#1 ARCADE HIT!

# AIRBORNE

TM

**WARNING**  
**MILITARY**  
**INSTALLATION**

*While on this installation all personnel and the property under their control are subject to search and seizure.*

**Photography Prohibited**  
*It is unlawful to make any photograph, film, map, sketch, picture, drawing, graphic representation of this area or equipment at any time over this installation.*  
See Internal Security Act of 1950; 50 U.S.C. 795

**USE OF DEADLY**  
**FORCE AUTHORIZED**



**MATURE**  
 TM  
**M**  
 AGES 17+  
 CONTENT RATED BY  
**ESRB**

# MIDWAY®

SLUS-00164

## **WARNING: READ BEFORE USING YOUR PlayStation™ GAME CONSOLE**

A very small percentage of individuals may experience epileptic seizures when exposed to certain light patterns or flashing lights. Exposure to certain patterns or backgrounds on a television screen or while playing video games, including games played on the PlayStation™ game console, may induce an epileptic seizure in these individuals. Certain conditions may induce previously undetected epileptic symptoms even in persons who have no history of prior seizures or epilepsy. If you, or anyone in your family has an epileptic condition, consult your physician prior to playing. If you experience any of the following symptoms while playing a video game - dizziness, altered vision, eye or muscle twitches, loss of awareness, disorientation, any involuntary movement, or convulsions - **IMMEDIATELY** discontinue use and consult your physician before resuming play.

## **WARNING TO OWNERS OF PROJECTION TELEVISIONS**

Do not connect your PlayStation™ game console to a projection TV without first consulting the user manual for your projection TV, unless it is of the LCD type. Otherwise, it may permanently damage your TV screen.

## **HANDLING YOUR PlayStation™ DISC**

- This compact disc is intended for use only with the PlayStation™ game console.
- Do not bend it, crush it or submerge it in liquids.
- Do not leave it in direct sunlight or near a radiator or other source of heat.
- Be sure to take an occasional rest break during extended play.
- Keep this compact disc clean. Always hold the disc by the edges and keep it in its protective case when not in use. Clean the disc with a lint-free, soft, dry cloth, wiping in straight lines from center to outer edge. Never use solvents or abrasive cleaners.

# CONTENTS

<b>Getting Started</b>	<b>3</b>
<b>Controls</b>	<b>4</b>
<b>Arcade Gun Controls</b>	<b>5</b>
<b>A Briefing to S.T.A.A.R Team</b>	<b>6</b>
<b>Main Menu</b>	<b>8</b>
<b>Battle Selection</b>	<b>9</b>
<b>Options</b>	<b>9</b>
<b>Player Select</b>	<b>10</b>
<b>Arcade Options</b>	<b>13</b>
<b>Sound Options</b>	<b>14</b>
<b>The Terrain</b>	<b>15</b>
<b>Primary Targets</b>	<b>17</b>
<b>Mission Status Reports</b>	<b>20</b>
<b>The S.T.A.A.R Team</b>	<b>21</b>
<b>The Enemy</b>	<b>22</b>
<b>Saving the Planet</b>	<b>24</b>
<b>The History Books</b>	<b>24</b>
<b>Credits</b>	<b>25</b>
<b>Warranty</b>	<b>26</b>

# GETTING STARTED

Set up your PlayStation™ Game Console according to the instructions in its Instruction Manual. Make sure the power is off before inserting or removing a compact disc. Insert the AREA 51™ disc and close the disc cover. Insert game controllers and turn on the PlayStation™ game console. Follow on-screen instructions to start a game.

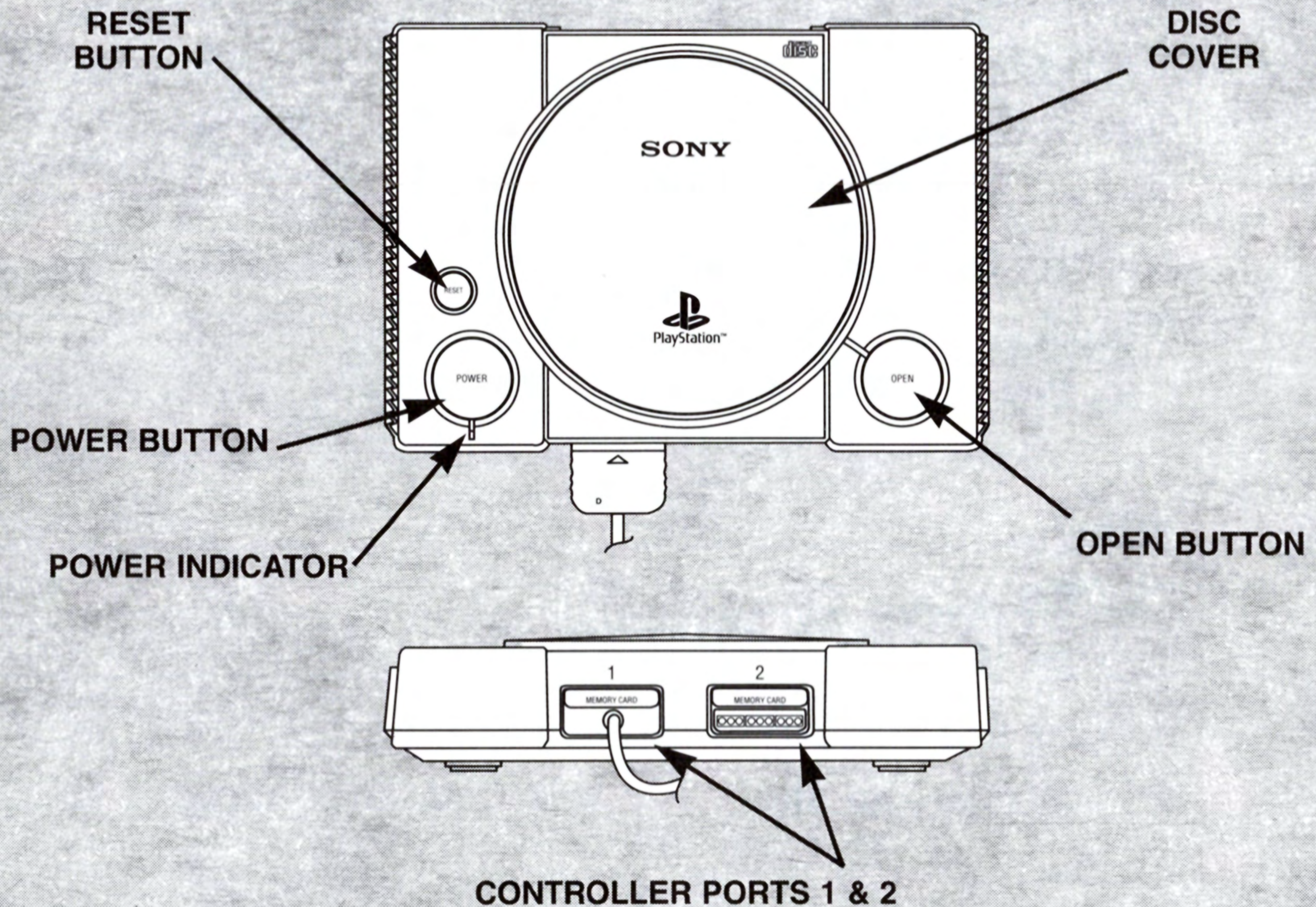

# CONTROLS

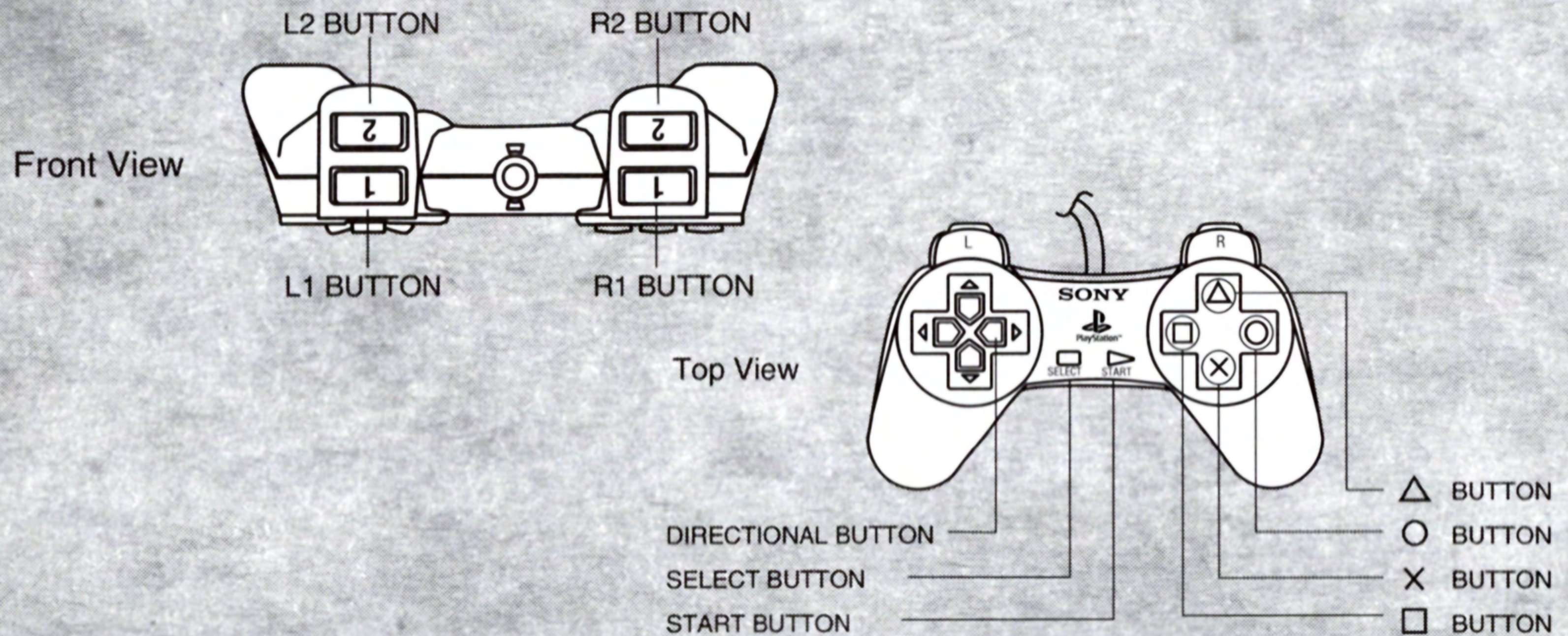

## CONTROLLER

Aim Crosshair

Fire Gun

Reload

Pause/Resume Play

Throw Grenade

Directional Button

**X Button**

**O Button**

Start Button

**□ Button**

## PLAYSTATION MOUSE

Aim Crosshair

Fire Gun

Reload

Throw Grenade

Mouse Forward, Back, Left, Right

Left Mouse Button

Right Mouse Button

Left click on the grenade displayed on-screen

# ARCADE GUN CONTROLS

TIP: ADJUSTING THE BRIGHTNESS LEVEL OF YOUR TV MAY IMPROVE LIGHT GUN ACCURACY. FOR BEST PERFORMANCE TRY TO POSITION END OF LIGHT GUN NO FURTHER THAN 3 FEET FROM TV SCREEN.

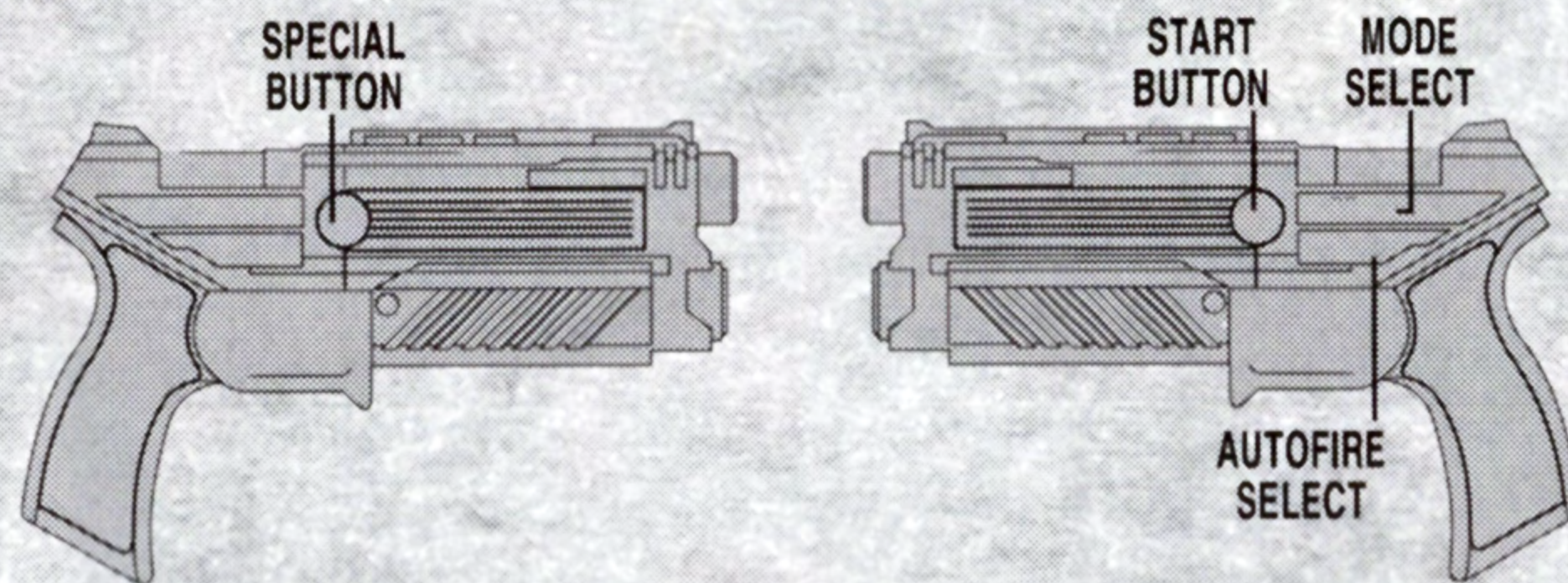

Pause/Resume Play: Press the **START Button**

Throw Grenade: Fire at grenade displayed on-screen

Reload Your Gun: Point gun off-screen, then pull trigger

Fire At The Target: Pull trigger

## MENU SELECTIONS

### USING YOUR GUN:

Aim the gun at the option you want to highlight.

Pull the trigger to select.

### USING YOUR CONTROLLER:

**Directional Button Up/Down/Left/Right** to move highlight.

Press the **X Button** to select options.

### USING YOUR PLAYSTATION MOUSE:

Move crosshair over the option to highlight it.

Click the Left Mouse Button to select.

To quit a game in progress, press **START**, then press **SELECT**. The Continue/Quit menu will appear. Select "**Quit**", then select "**Yes**" to exit the game, or select "**Continue**" to return to your game.

**A BRIEFING TO S.T.A.A.R TEAM**  
**DEPARTMENT OF NATIONAL DEFENSE**  
**S.T.A.A.R. DIVISION**  
**LIEUTENANT GENERAL G. ILOVEWAR**  
**COMMANDING OFFICER**

From: G. ILOVEWAR, LGEN, USMC

To: S.T.A.A.R. Team Troops

Re: Alien Invasion

What you are about to read is a confidential file drafted three days ago. It was recently E-mailed to an unknown source in the CIA and has found its way into our hands. It's origins are unknown at this time, but it is believed that it originated at a secret military base known as Area 51. This base is so top-secret that, officially, it does not exist.

Area 51 is located in a remote valley 90 miles outside of Las Vegas. It is one of the most well-guarded bases in the world. Rumors and eyewitness accounts also suggest the base harbors a deeper, more secret purpose. Secret biological testing has been reported, as well as experiments on alien bodies taken from a spacecraft which crashed near Roswell, New Mexico in 1947.

Over the course of the last 48 hours, the base has become overrun with mutating alien creatures, and all contact has been lost.

Security around the base is tight and so critical that it isn't handled by the military. Instead, it is contracted out to a

privately run paramilitary force. We now know that this force and all of its weaponry has also been overtaken.

The invasion did not take place from the air. Instead, an alien infection has spread out of the underground laboratory area to other parts of the base. The infection brings forth three separate, very painful stages of a gruesome alien transformation. The human body is used as an incubator to grow a new combination of human and alien DNA.

The product of this alien transformation is now our enemy. (See **The Enemy**, pg. 22 of this document for details on the three mutation stages and photos).

This file was obviously drafted by a highly trained soldier in the last hours of his life. It describes a detailed method of invading the base to attempt an extermination of the alien presence. Follow the instructions in this file to the letter. Portions of the document have been edited by S.T.A.A.R for security purposes. The fate of humanity hangs in the balance.

Good Luck.

*G. Ilovewar*

G. ILOVEWAR  
LGEN, USMC



# MAIN MENU

From the opening demo sequences, press **START** to exit and view the Title Screen. Press **START** again to exit the Title Screen and go to the Main Menu. Make a selection from the following options:

## **ARCADE**

This is it! Throw yourself right into the action. Good luck. I hope you know what you're doing. You'll go to the Battle Selection Screen (see **Battle Selection, pg. 9**).

## **PRACTICE**

Before you blindly attempt to save the planet, you'll need some training. Select this option to prepare yourself for your suicide mission. Aim and fire at the targets to get used to your weapon's accuracy.

## **OPTIONS**

You DO have some options that MAY give you a chance against the Kronomorphs. Make this selection to view them (**see pg. 9**).

## **HIGH SCORES**

Select this option to view the names and accomplishments of the men and women who performed best in battle against the enemy.

## **EXIT**

This option quits the game and returns you to the Demo.

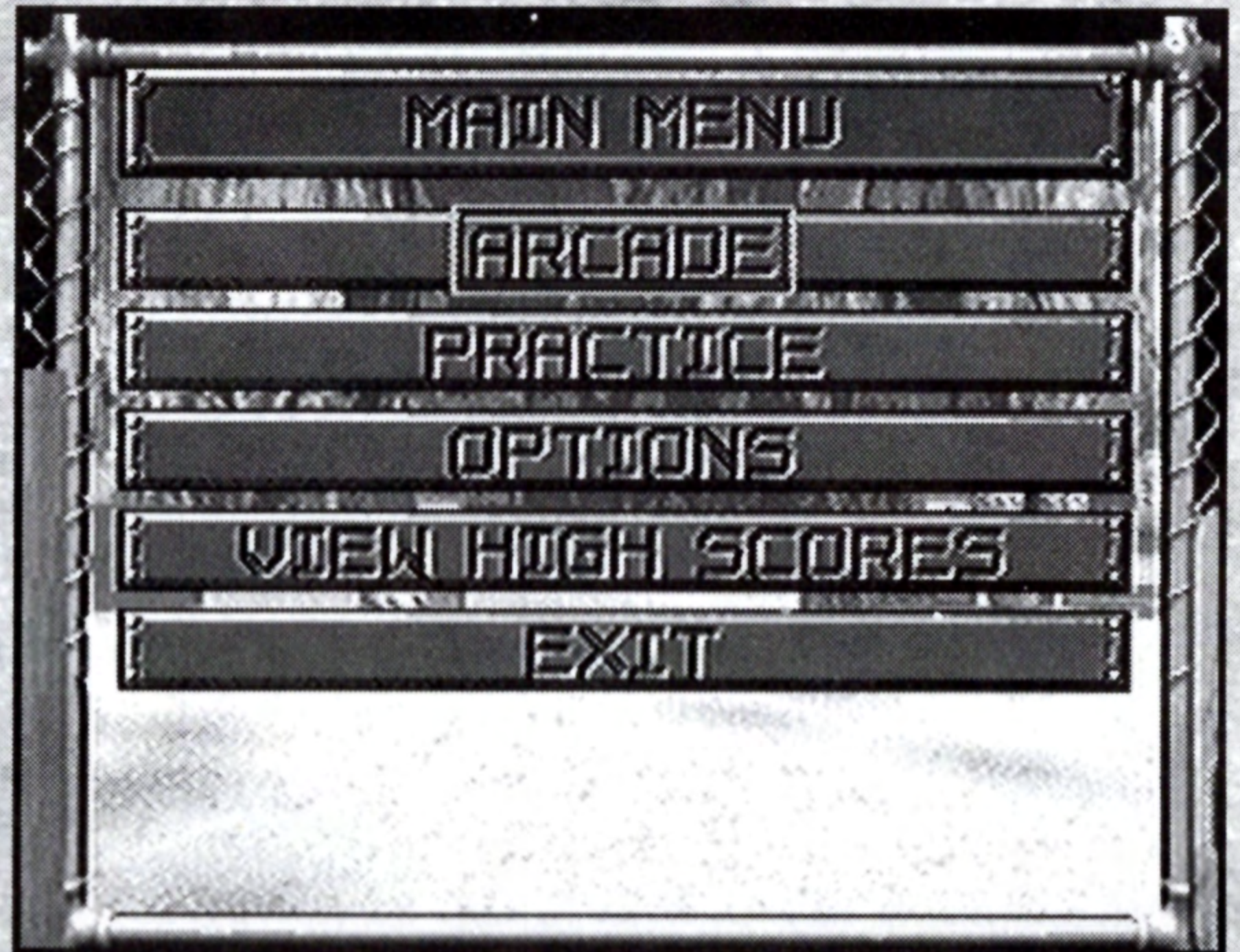

## BATTLE SELECTION

You have two choices: You can begin the mission at the **Beginning** or **Warp Ahead** to get right in the thick of the Alien Forces. When you make your choice, move the crosshair over the selection, then click the **Left Mouse Button**. Get ready, you'll be dropped right into some heavy gunfire. We'd wish you good luck, but unfortunately you'll need more than that.

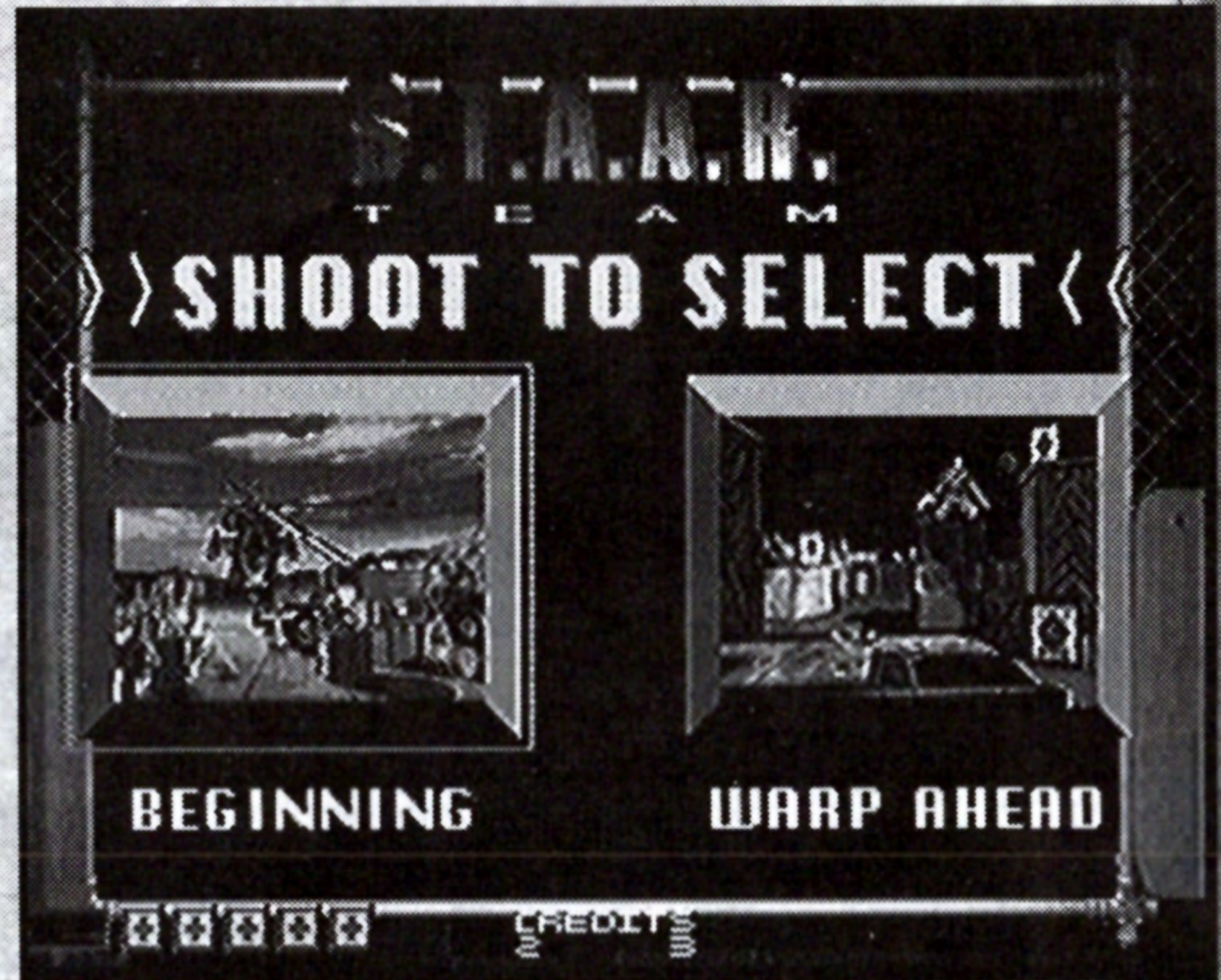

## OPTIONS

The following options will let you carefully plan your attack on the military base. Study each option and make the changes that best suit your ability. In most cases you will be sent to succeeding pages to effect your changes.

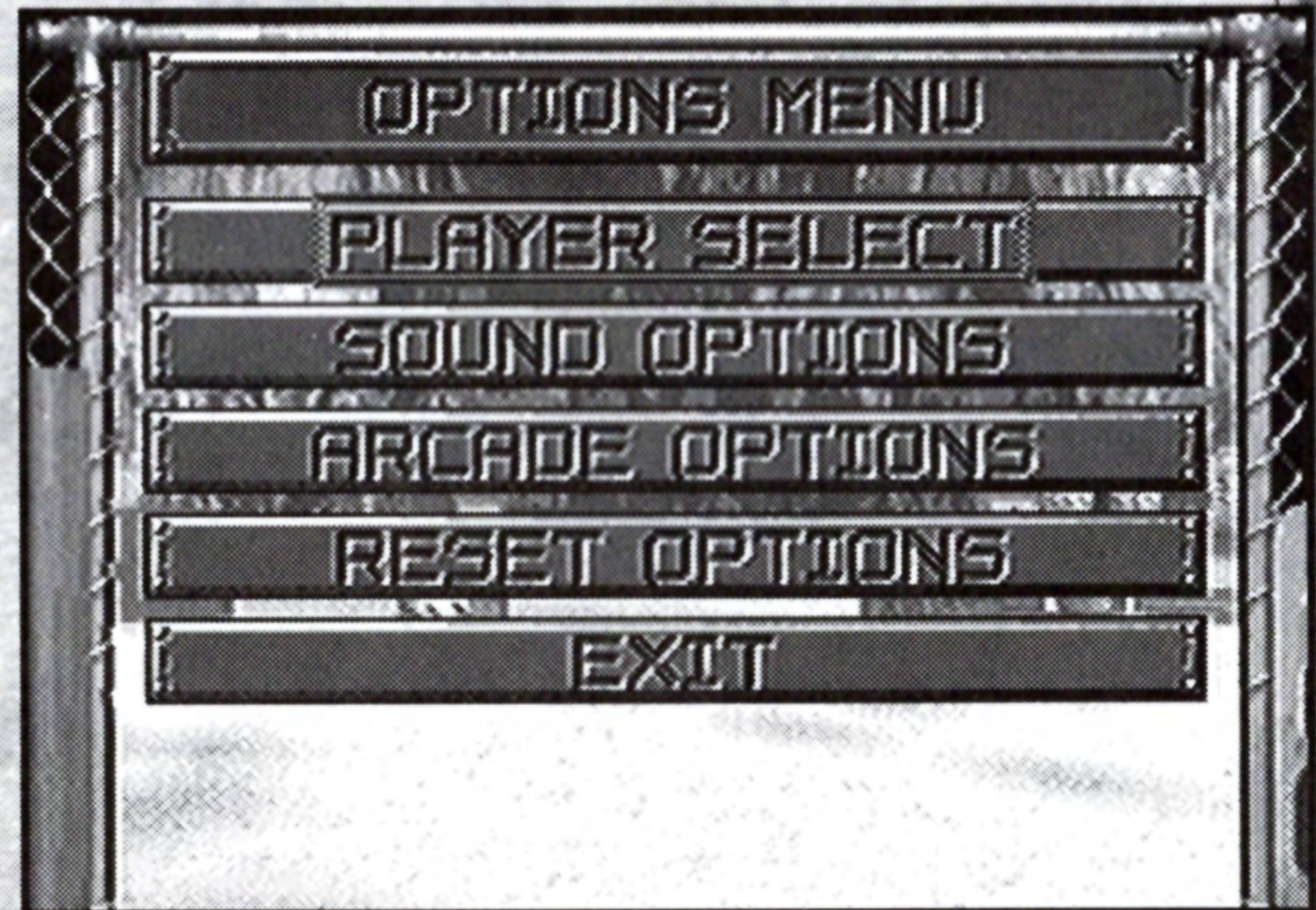

# OPTIONS

## PLAYER SELECT

This option lets you make control modifications to your Controller, Mouse or Gun.

## SOUND OPTIONS

You can modify the sound configuration for the game. ( **See page 14** ).

## ARCADE OPTIONS

Select from various options to configure the game the way you want.

( **See page 13** )

## RESET OPTIONS

Click here to reset your ARCADE OPTIONS to their defaults.

## EXIT

Select **EXIT** to get back to the MAIN MENU.

## PLAYER SELECT



Make modifications to your controller. Here are the choices:

### CONFIGURE P1/P2

Select this option to configure your Controller, Mouse or Gun.

The configuration screen will change based on whether the gun, mouse or controller is plugged into the port you select.

**For example:** If your gun is in controller port 1, select **Configure P1** to view the Configure Gun Screen.

# PLAYER SELECT

## CONFIGURE MOUSE

**Mouse Speed** - This option changes the speed of your pointer movement in relation to the mouse. Click your mouse on the slide bar to change the setting. Move your mouse around to test the new setting.

**Swap Buttons** - This option reverses the default controls for the Left and Right Buttons on your mouse. On the **NO** setting, the Left Button will fire weapons and select menu items, and the Right Button will reload. The **Yes** setting will reverse the two.

## CONFIGURE GUN

Follow these steps to calibrate your gun:

**1** Press **START** to cycle through the gun configuration options and highlight **Test**. Aim and fire at the alien in the target screen. Bullet holes will appear as you shoot. Make sure the bullets are hitting your target. You don't want your weapon to jam in the face of your enemy.

**2** If the bullet holes appear where you're aiming, you won't need to calibrate the gun. Select **Exit** to return to the Player Select Menu. If they are not hitting your target, go to Step **3**.

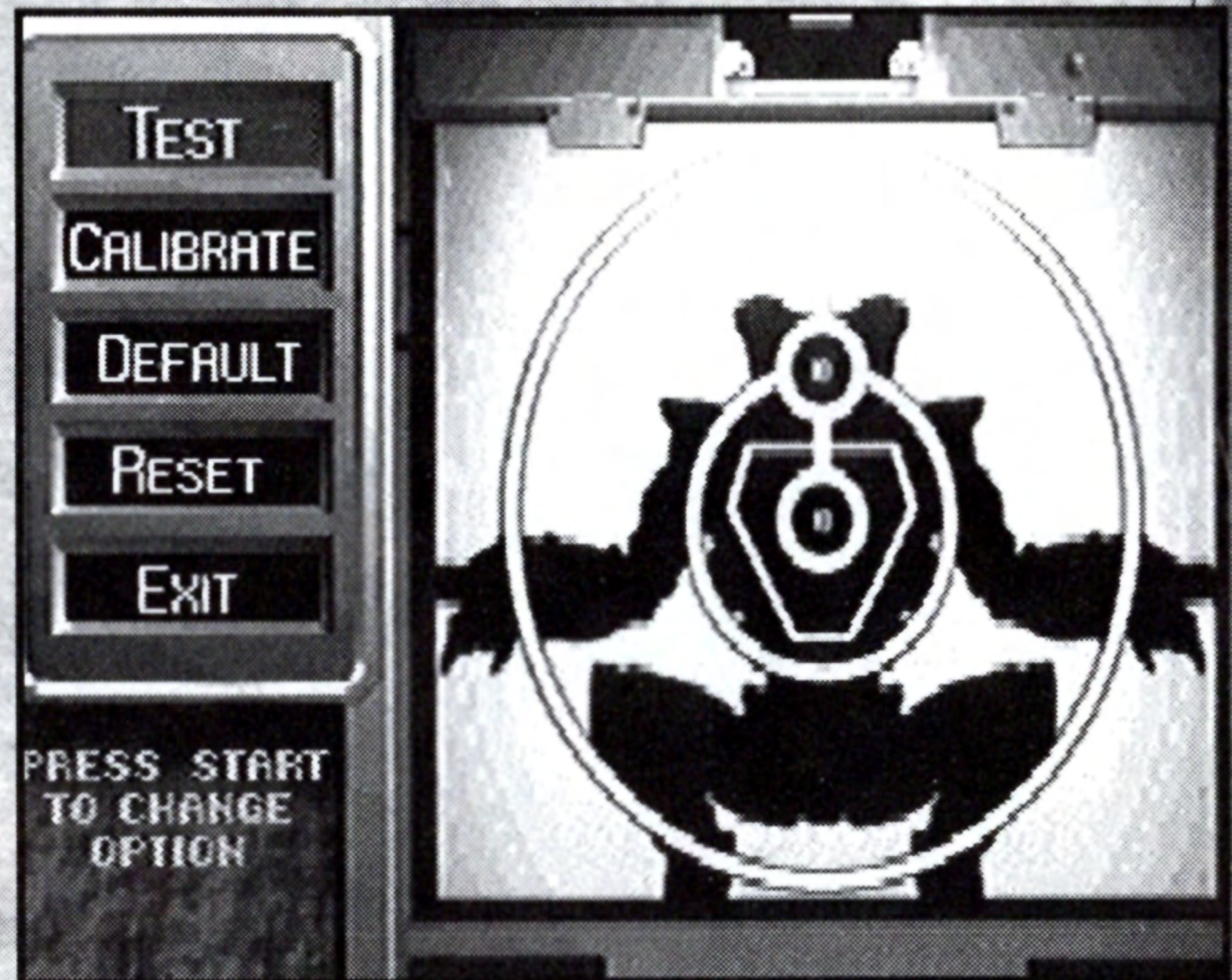

# PLAYER SELECT

- 3 Select **Calibrate** from the menu. A red light will flash within the target area. Aim at the target, then pull the trigger to calibrate it.
- 4 Follow Step 1 to test your aim again. Select **Reset** to erase your calibration, and repeat the entire process if necessary.
- 5 Select **Default** to return to the games default setting.

## CONFIGURE CONTROLLER

To configure your controller the way you want, press **Any Button** (other than **START**) to cycle the different configurations. The screen will display the new action, and assign it to a new button. When you find the configuration you like, highlight **Exit** and press **START**. Select **Cancel** to disregard any changes you've made and return to the Player Select Screen. Select

**Default** to reset any changes to you've made to the original settings. When you've finished making any changes, highlight **Exit** and press **START**.



## ARCADE OPTIONS

**DIFFICULTY**--Area 51 has five different difficulty levels to choose from. Select from **Novice**, **Easy**, **Medium** (default), **Hard** and **Expert**.

**LIVES**--Set the amount of Lives you can have to make things really difficult. Select from **3** to **5** lives. You'll continue to play until all of your lives are gone.

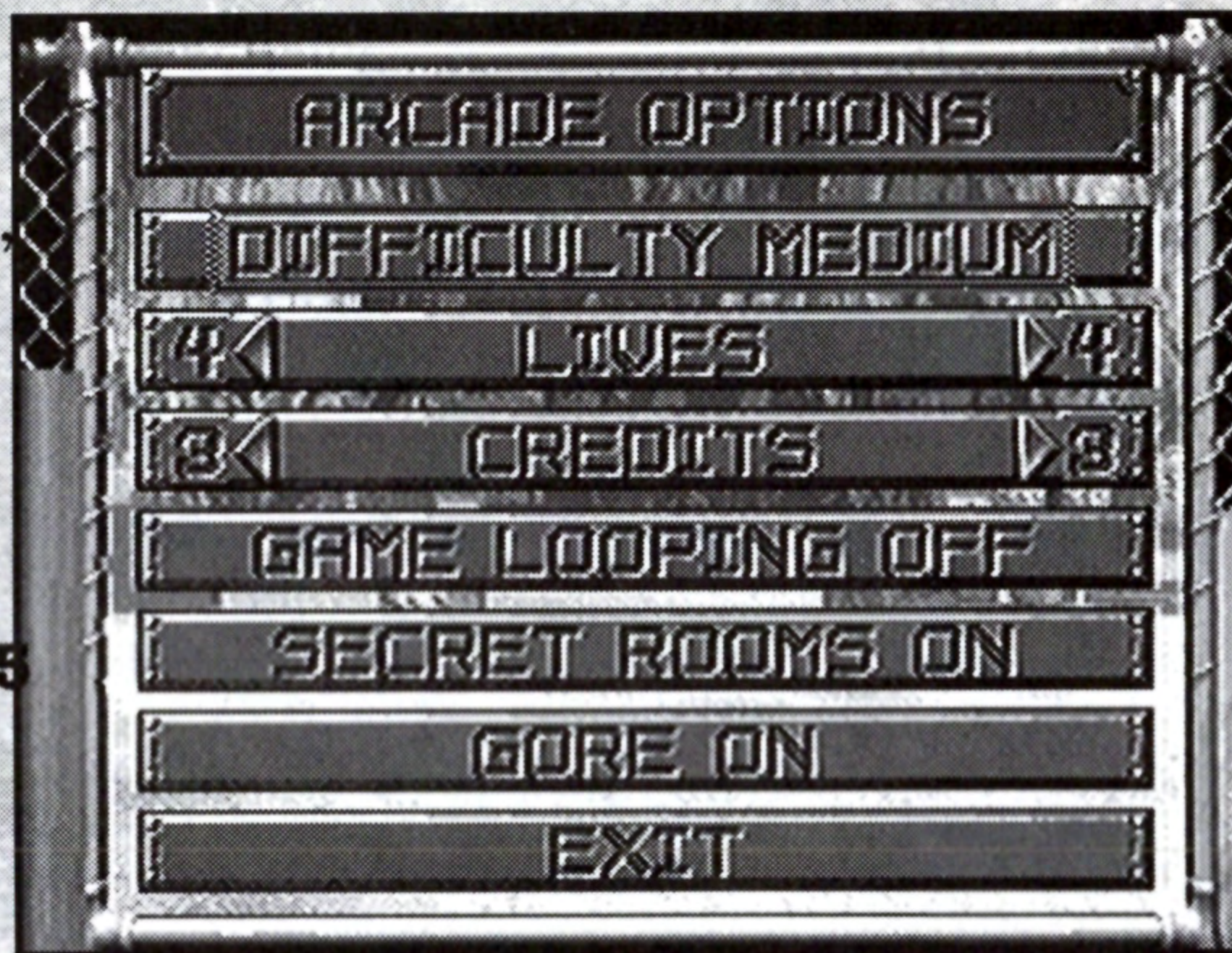

**CREDITS**--When you run out of Lives, the game will stop. You'll be prompted to Continue the game. If you have credits left, press **START** to continue the game. Select from **1** to **7** credits to extend your game. When you're out of credits, the game ends. **Note:** When you use your credits to Continue a game, your current score is reduced by 25%.

**GAME LOOPING**--Set this option to **On**, and the game will loop to the beginning, once you've completed the entire game. Your accumulated points, weapons and ranking will carry over. Select **Off** to have the game end when you've saved the world.

**SECRET ROOMS**--Turn this option to **Off** to play the game without entering any Secret Rooms. Default is **On**.

**GORE**--Turn this option **Off** for no blood. Default is **On**.

**EXIT**--Select to return to the **OPTIONS** menu.

## SOUND OPTIONS

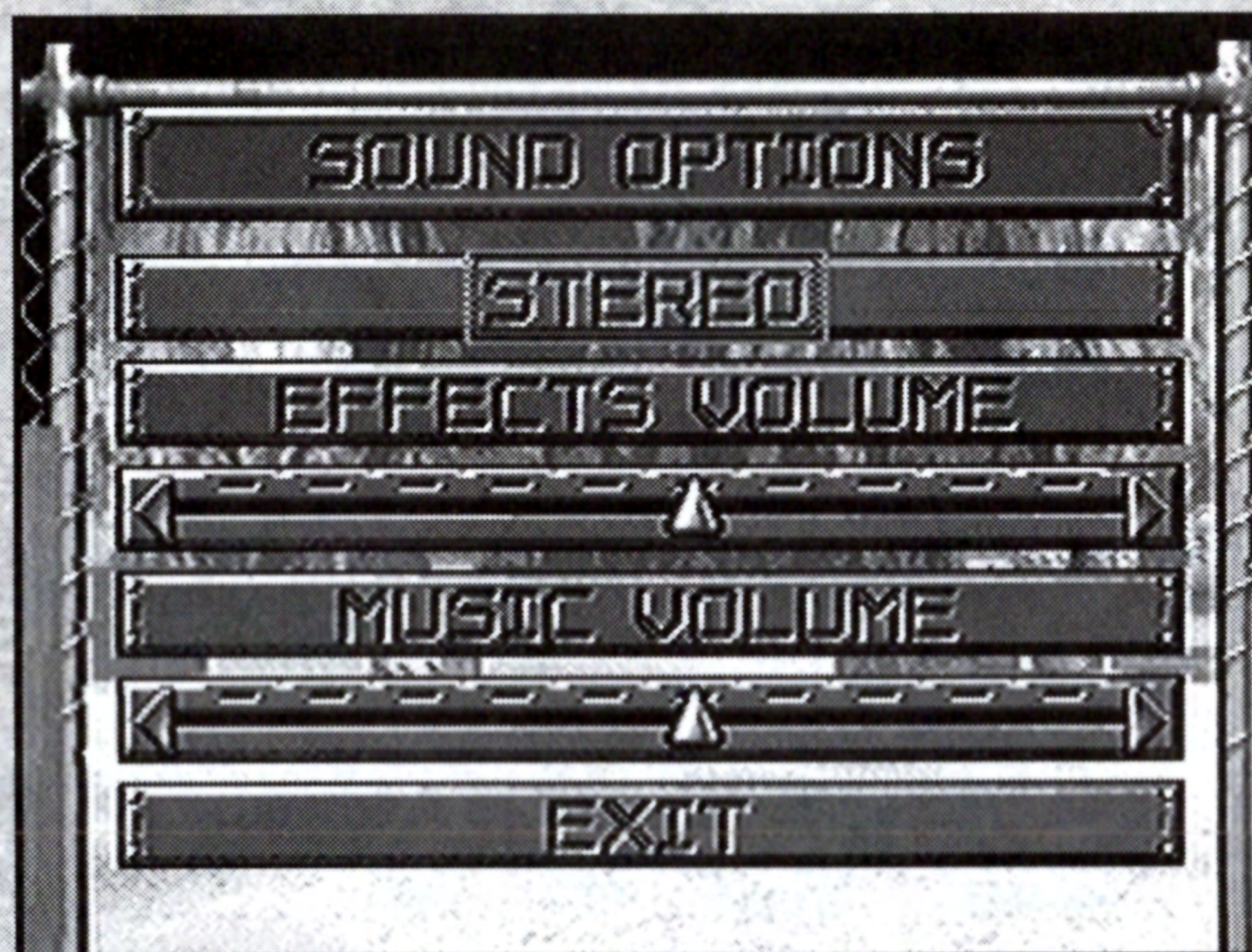

You can modify the sound configuration for the game. Select the **STEREO / MONO** option to toggle between the two settings. You can also set the **EFFECTS** and **MUSIC** volumes the way you want. Select **EXIT** to accept the changes and return to the Options Screen. Use your Controller to move the slide bar and change the setting. Changes will occur as you raise or lower the volume.

# THE TERRAIN

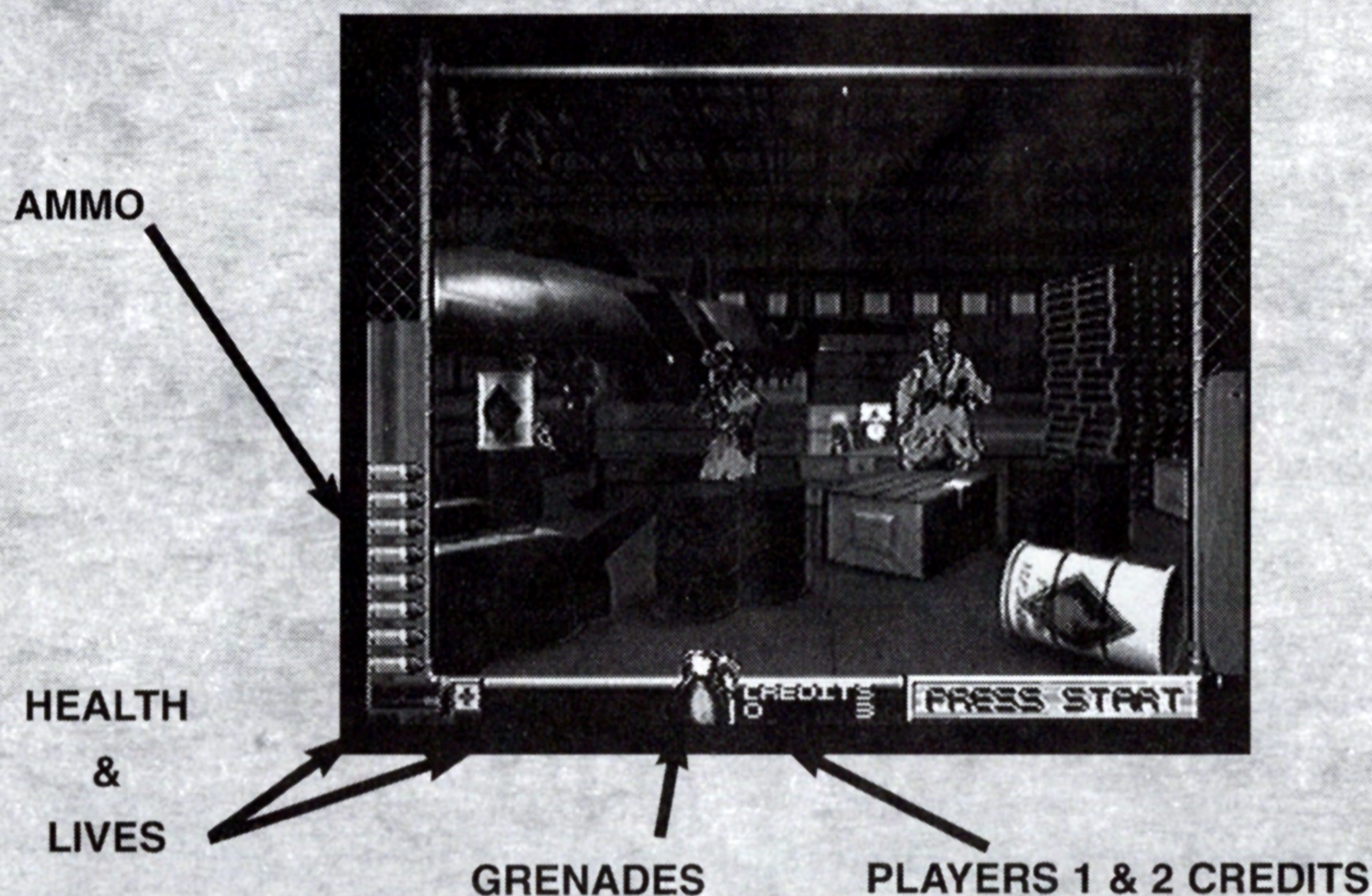

As you scramble for your life Inside the base, you'll have a constant view of your Ammunition, Health, Grenades and the base. The amount of Credits for you and your buddy are also displayed.

## **Ammunition**

You are issued the standard ammunition for the mission, but you can accumulate two other types of rounds. Shoot every Power Up (see **Power Ups, pg. 17**) you see to accumulate these other types of rounds:

**Machine Gun Shells** - When you pick these up, hold the trigger down and watch the aliens bite the dust. Be aware, though, your ammo will go fast. Reload as often as possible.



# THE TERRAIN

**Shotgun Shells** - These are powerful and great to have. The downside is the amount of rounds per clip. Reload as often as possible. If you hit another Power Up while you're using these, you'll fire automatic rounds if you hold down the trigger.

**Note:** These two types of ammunition are limited in quantity. Be aware that they will run out, and you'll have to use your standard rounds until you pick up more.

## **Health and Lives**

Your heart rate is always monitored. The faster your heart rate, the closer you are to "checking out". Stay low and shoot them before they shoot you. The amount of Med Kits displayed represents the amount of direct bullet hits you can take. You can adjust this amount (see **Lives, pg. 13**).

## **Grenades**

To possibly find grenades, shoot any Ammo Crates (see **Ammo Crates, pg. 18**) you see. These come in handy when an area gets too hot. If you find yourself surrounded, shoot the grenade. It will take out anything around you, except those ugly Purple Kronomorphs. You've got to plug them full of holes before they go down. The amount of grenades on your person is displayed on the grenades read-out.

## **Credits**

The amount of credits remaining in your mission is displayed for you and your buddy. You can modify this amount (see **CREDITS, pg. 13**).

# PRIMARY TARGETS

The obvious targets are the Kronomorphs and Zombies, but you're under orders to shoot many other items as well. Study these things carefully before you begin:

## **Power Ups**

You'll find these hovering in the air as you move throughout the base. Shoot them to acquire larger, more powerful ammunition. When you hit a Power Up, your ammunition will change to Shotgun or Machine Gun rounds. You can achieve an automatic Shotgun by hitting a Power Up while you still have remaining Shotgun Shells.



## **Barrels**

Yellow barrels are scattered throughout the base. These are favorite hiding places for the Zombies, so shoot as many as you can. They explode and take out anything in proximity. Destroying them adds to your Streak (see **Streak, pg. 20**) performance and may also unlock secret rooms.

# PRIMARY TARGETS

## **Ammo Crates**

Locked ammunition crates are found all over the base. Shoot them open to recover grenades or extended ammo clips. The clips come in handy when you don't have much time to reload.

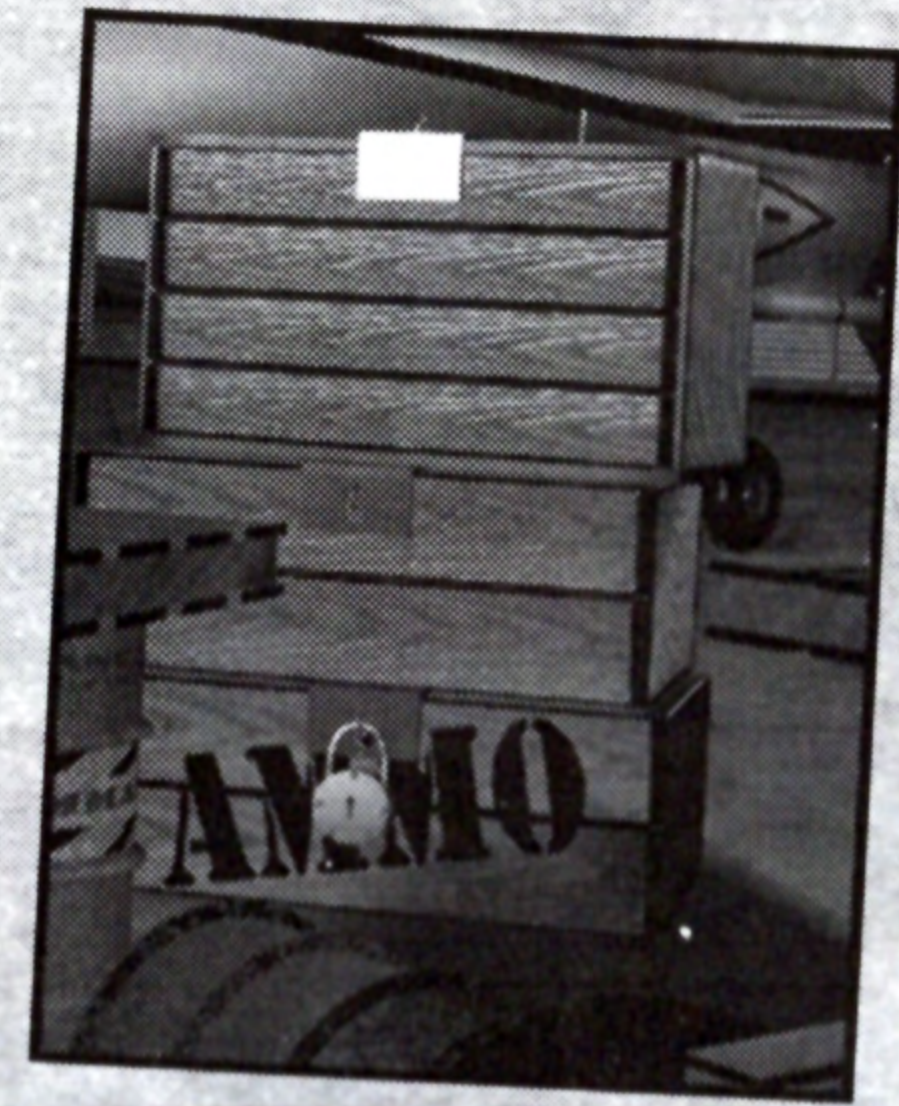

## **Windows**

This is a simple order: See a window? Shoot it! Windows unlock secret rooms and add to your Streaks (see **Streak, pg. 20**). Shoot out the windows in vehicles and in rooms.



## **Fire Extinguishers**

Shoot Fire Extinguishers when you can. The force of the explosion will take out an Alien close by. It will not, however, kill the purple Kronomorphs.

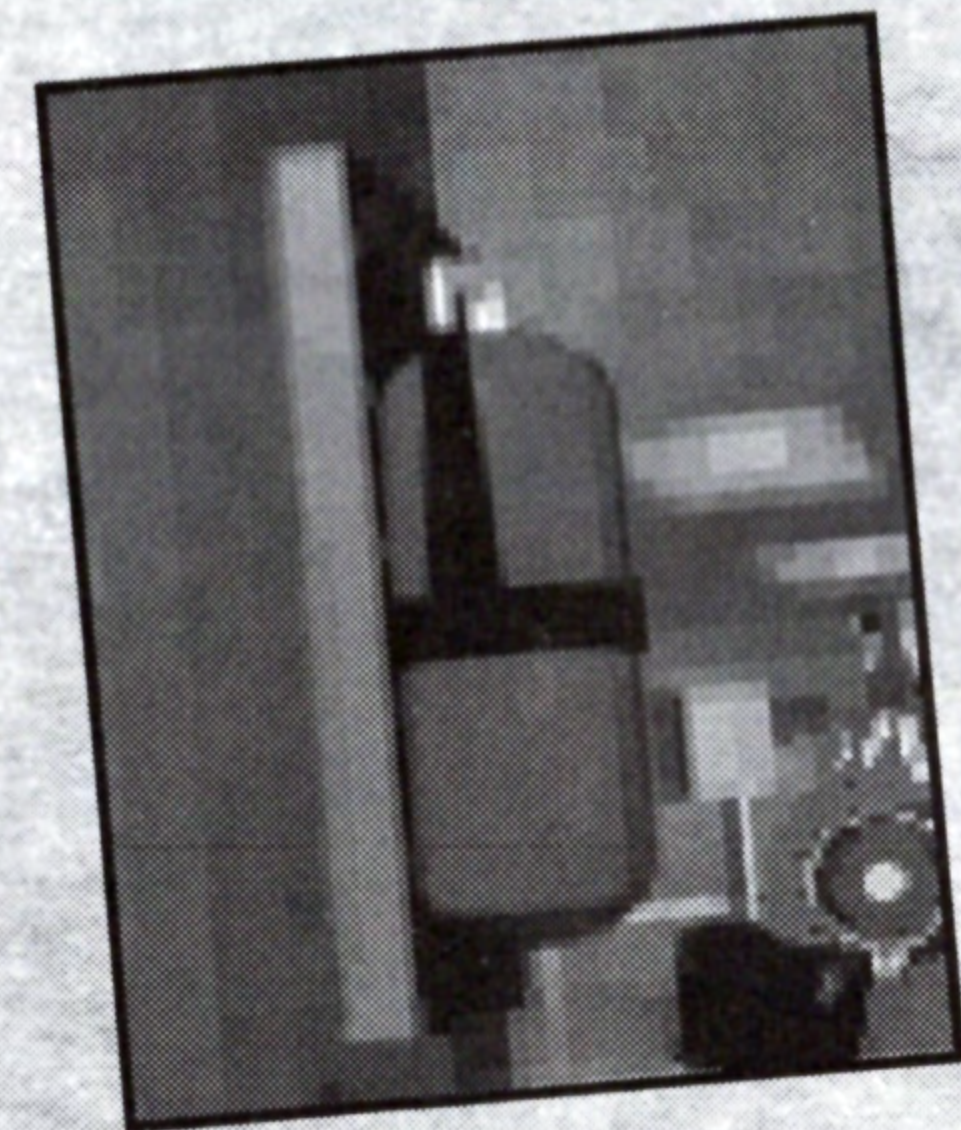

# PRIMARY TARGETS

## Paintings

It may sound irrational, but you are under orders to shoot the paintings, too. For some reason, they may give you grenades or access to secret rooms.



## Machinery

Destroy all computer equipment and any other items on desks and tabletops. We need to cut off their contact to the outside world.

## Secret Rooms

**AREA 51** has many of these rooms. Unfortunately, there's no information available at this time regarding their location and quantity. We strongly suggest that you shoot everything in sight. The rooms will present themselves if you've hit the right combination of targets.

# MISSION STATUS REPORTS

**RANK** - You can keep track of any promotions by looking at your Mission Status Reports. Your rank will be displayed at the top of the report.

**ACCURACY** - The ratio of Shots Fired and Targets Hit is tallied during each stage. Your hit percentage is recorded.

**KILLS** - You better have a lot of these. Each time you make a Kill, it is counted on your report.

**STREAK** - As you shoot and destroy, you are rewarded for accuracy. When you hit your targets without a miss, the amount of targets you hit in a row will be displayed. This skill is taken into account when your Rank is determined.

**SHOTS** - The amount of shots fired is accumulated during battle. Keep your Shot count down and your Kill count up to receive the highest points toward a promotion.

**DAMAGE** - This number represents the objects you've destroyed. The more barrels, crates, etc. you shoot, the higher the number.

**TOTAL SCORE** - Your cumulative points for any completed stages is given.

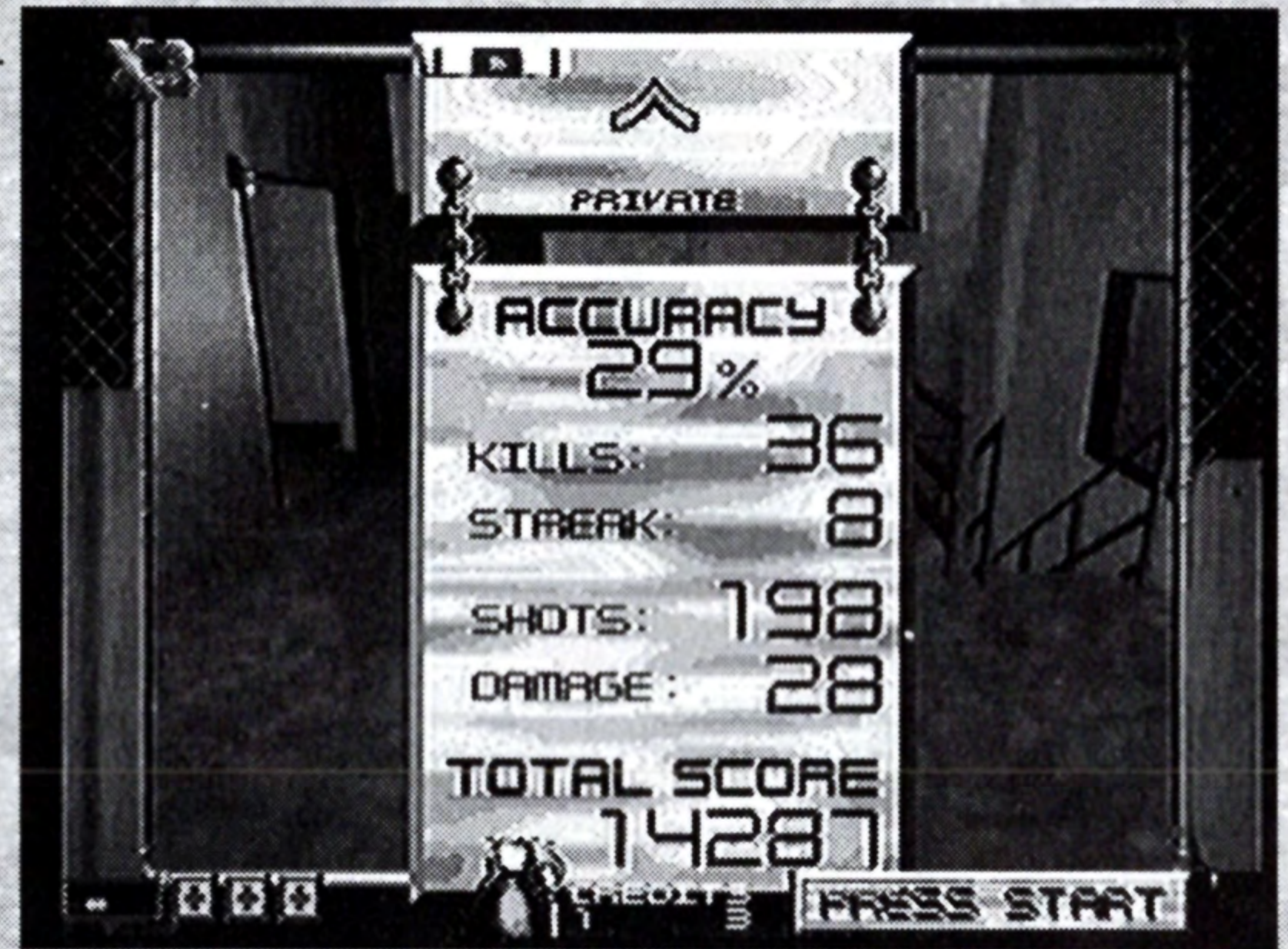

# THE S.T.A.A.R. TEAM

## A BRIEF HISTORY:

Formed in 1958 at the height of the Cold War, the creation of the *Special Tactical Advanced Alien Response* (S.T.A.A.R.) was a direct response to the threat of armed alien invasion.

In the years after World War II, as US and USSR pilots continuously set new high altitude and performance records, an increasing number of strange aircraft sightings were reported near the boundary of Earth's stratosphere. Most of these were written off to the extreme effects of high-altitude navigation, which can cause hallucinations and "gray-outs," often causing pilots to see light. Some of these pilots, though, were adamant in their belief that there was something else "out there" in space, watching us.

A S.T.A.A.R. Point Team has been dispatched for the assault on **AREA 51**. The team's soldiers wear bright blue and are clearly marked with "S.T.A.A.R." on their uniform. PAY ATTENTION - DO NOT SHOOT THEM. Friendly Fire costs lives.



# THE ENEMY

The Kronomorphs were designed to quickly and rapidly accept the latest "weapons" codes that the Kronn geneticists have developed. As a result, they are hot-beds for fast DNA assimilation and replication, integrating DNA into their systems and using the information in a matter of days or even hours. They are creatures that can adapt to their environment with rapid speed, adopting the best traits of the various species around them. Still, for all of their genetic abilities, the Kronn scientists have kept the Kronomorphs deliberately stupid, and they have remained that way, obeying the orders of their Kronn masters as if they were a strange combination of warrior and mind-controlled slave. Study these profiles very closely. You'll know these creatures when you see them, but you'll need to know this background information before going in.

## ZOMBIE **Metamorphosis: Stage 1**

Human flesh turns gray and begins rotting from the body, drooping into large folds. An alien larva begins growing within the body, roughly taking the shape of the human skeleton.

## UNKNOWN **Metamorphosis: Stage 2**

We have word-of-mouth reports about Stage 2, but no documentation or pictures. It is a short, very painful transitional stage where the alien literally explodes out of the incubating human sac. Because of the rapid speed of genetic replication, the host body



# THE ENEMY

needs a large source of raw bioplasma, and at this stage the mutants must feed voraciously. In addition to being replicatory hosts, humans are also a source of food. Reports have come in about a room called the Chow Palace, where Stage 2 aliens may have been sighted. We can't confirm any information at this time.

## KRONOMORPH **Metamorphosis: Stage 3**

Stage 3 is the full blown alien stage. The alien is heavily armored and extremely fast, and can grow bioplasma weapons from its own flesh. These include a plasma based particle beam and hardened calcium carbonate projectiles. The alien has one large eye in the center of its head, which can project light as well as scan terrain for heat patterns. Two smaller eyes in the middle of the head monitor our conventional light spectra. Aliens feed through a large mouth in the center of the chest, assisted and protected by six functional arms that fold over when not in use. Reports have surfaced about purple Kronomorphs that can withstand multiple rounds of fire. Pump some lead into these guys, and they should go down.

**Kronomorph** - the virulent evolved form; quick and lethal.





# SAVING THE PLANET

No information or guidance available re: this subject. We DO have reports (see message below) that there is an Alien Spacecraft somewhere on the base. We suggest you destroy all alien beings, then concentrate on destroying the ship; if it exists. You'll only have your guns to work with, so make every shot count.

(CLASSIFIED) FINAL TRANSMISSION FROM AREA 51 PERSONNEL.

**"...UNIDENTIFIED ALIEN SPACE CRAFT RUMORED TO BE WITHIN FACILITY PERIMETER...TERMINATE ALIEN BEINGS FIRST PRIORITY...SEARCH & DESTROY VESSEL SECONDARY PRIORITY..."** end of transmission

## THE HISTORY BOOKS

If you survive this suicide mission, the history books will regard you as a hero for all time. Following a successful mission, you may enter your name in the books. Here's how:

- Aim the crosshair over the character you want, then press the **Fire Button**.
- Repeat **Step 1** until you've completed your entry. Select the (left) arrow to back up and fix mistakes. Select **Done** to enter your name. Your name will be displayed as one of the Top Ten S.T.A.A.R. Soldiers to take on the Kronomorphs. Congratulations on a job well done!

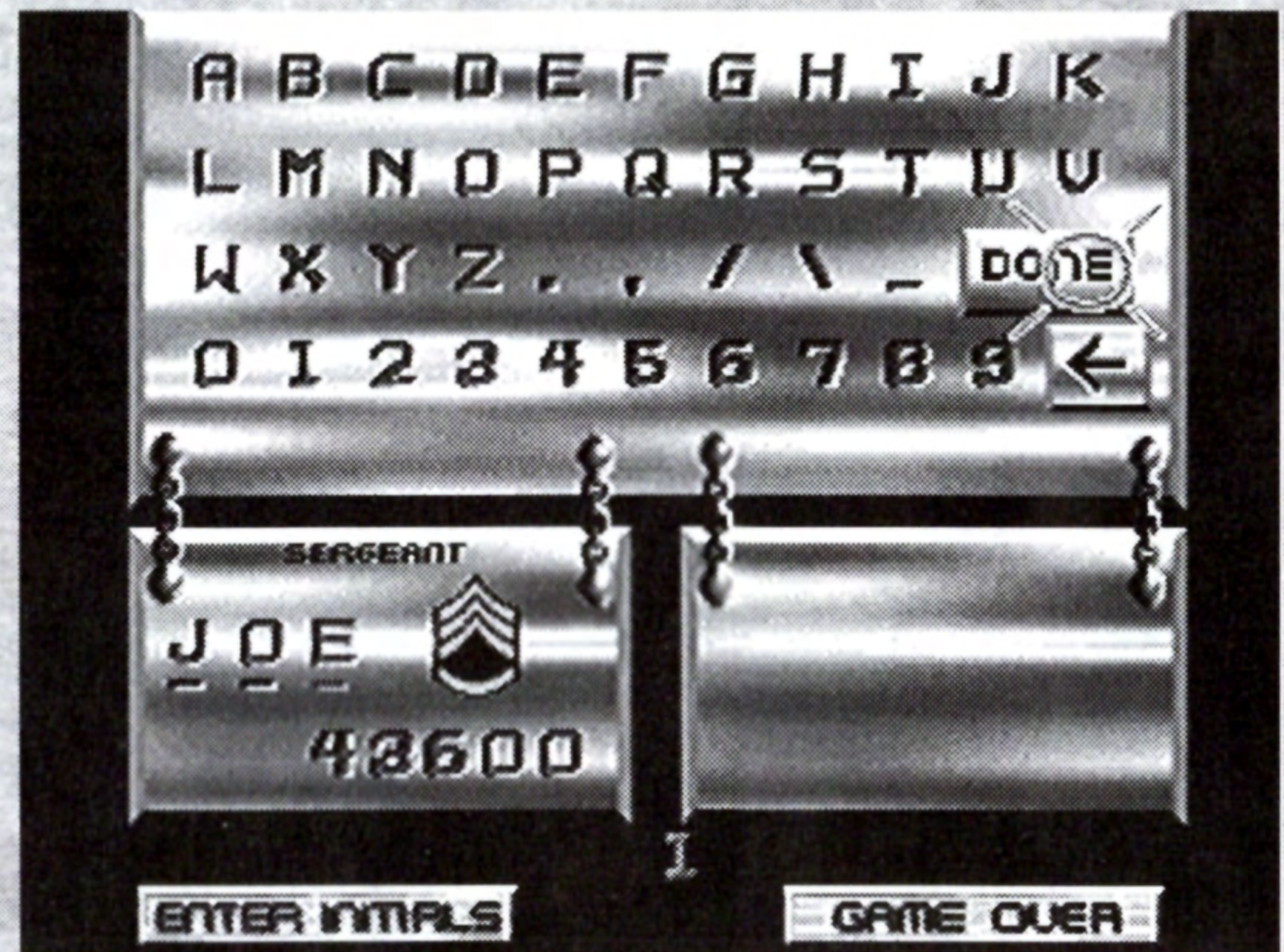

# CREDITS

## MIDWAY TEAM

**Producers** Ken Humphries, Bill Hindorff, Howard Lehr  
**Test Supervisor** Mike Kruse  
**Lead Tester** Randy Slafsky  
**Testers** Todd Papy, Chris Thornton, Jesse Meza & Pablo Buitrago  
**Print Design & Production** Debbie Austin, Shawn Murphy, Dave Young  
Jon Mongelluzzo & Robert Shepherd  
**Special Thanks** Brian Fritts & Tona Hess

## ATARI TEAM

**Producer** Rob Rowe  
**Programmer** Charlie Grisafi  
**Game Design** Mike Hally  
**Art & Design** Steve Caterson  
**Video Production** Brent Englund  
**Lead Technician** Darrell Robinson  
**Stop-Motion Animator** Jody Burgess  
**Product Manager** Derryl DePriest  
**Audio & Music** Jeanne Parson and Michael Stein  
**Hardware Engineer** Brian McKee

## MESA LOGIC TEAM

**Concept & Game Design** Robert Weatherby  
**3D Animators** James Mestemaker, Guy Fumagalli, Hector Silva & James Webb

## TANTALUS ENTERTAINMENT TEAM

**Programmer** Trevor Nuridin  
**Artist** Alun Bjorksten  
**Executive Producer** Arthur Kakouris  
**Quality Assurance** John Szoke  
**Technical Director** Andrew Bailey

## PERFECT ENTERTAINMENT TEAM

**Producer** Colin Fuidge  
**Quality Assurance** Matt Stamps

# WARRANTY

MIDWAY HOME ENTERTAINMENT INC. warrants to the original purchaser of this Midway Home Entertainment Inc. software product that the medium on which this computer program is recorded is free from defects in materials and workmanship for a period of ninety (90) days from the date of purchase. This Midway Home Entertainment Inc. software program is sold "as is," without express or implied warranty damages of any kind, and Midway Home Entertainment Inc. is not liable for any losses or damages of any kind resulting from the use of this program. Midway Home Entertainment Inc. agrees for a period of ninety (90) days to either repair or replace, at its option, free of charge, any Midway Home Entertainment Inc. software product, postage paid, with proof of purchase, at its Factory Service Center.

This warranty is not applicable to normal wear and tear. This warranty shall not be applicable and shall be void if the defect in the Midway Home Entertainment Inc. software product has arisen through abuse, unreasonable use, mistreatment or neglect. THIS WARRANTY IS IN LIEU OF ALL OTHER WARRANTIES AND NO OTHER REPRESENTATIONS OR CLAIMS OF ANY NATURE SHALL BE BINDING ON OR OBLIGATE MIDWAY HOME ENTERTAINMENT INC. ANY IMPLIED WARRANTIES APPLICABLE TO THIS SOFTWARE PRODUCT, INCLUDING WARRANTIES OF MERCHANTABILITY AND FITNESS FOR A PARTICULAR PURPOSE, ARE LIMITED TO THE NINETY (90) DAY PERIOD DESCRIBED ABOVE. IN NO EVENT WILL MIDWAY HOME ENTERTAINMENT INC. BE LIABLE FOR ANY SPECIAL, INCIDENTAL, OR CONSEQUENTIAL DAMAGES RESULTING FROM POSSESSION, USE OR MALFUNCTION OF THIS MIDWAY HOME ENTERTAINMENT INC. SOFTWARE PRODUCT.

Some states do not allow limitations as to how long an implied warranty lasts and/or exclusions or limitations of incidental or consequential damages so the above limitations and/or exclusions of liability may not apply to you. This warranty gives you specific rights, and you may also have other rights which vary from state to state.

MIDWAY HOME ENTERTAINMENT INC.  
1800 SOUTH HIGHWAY 45  
CORSICANA, TX 75110

**MIDWAY CUSTOMER SUPPORT**  
**903 874-5092**

**10:00am - 6:30pm - Central Time**  
**Monday - Friday**

**MIDWAY**

**MIDWAY Home Entertainment Inc**  
1800 South Business 45  
Corsicana, Texas 75110

AREA 51™ ©1995 ATARI GAMES CORPORATION. ALL RIGHTS RESERVED. DEVELOPED BY MESA LOGIC, INC. CONVERTED BY TANTALUS AND PERFECT ENTERTAINMENT LTD. AREA 51™ IS A TRADEMARK OF ATARI GAMES CORPORATION. DISTRIBUTED BY MIDWAY HOME ENTERTAINMENT INC. UNDER LICENSE FROM ATARI GAMES CORPORATION. MIDWAY® IS A REGISTERED TRADEMARK OF MIDWAY GAMES INC. USED BY PERMISSION.

Licensed by Sony Computer Entertainment America for use with the PlayStation game console. PlayStation and the PlayStation Logos are trademarks of Sony Computer Entertainment Inc. The ratings icon is a trademark of the Interactive Digital Software Association. Manufactured and printed in the U.S.A. THIS SOFTWARE IS COMPATIBLE WITH PLAYSTATION GAME CONSOLES WITH THE NTSC U/C DESIGNATION. U.S. AND FOREIGN PATENTS PENDING.

